

nurus

XXL Collection

Design by **Nurus D Lab**



The ultimate preparation for your next big meeting.

Meetings are about making decisions. Meeting halls and conference rooms are high priority areas that reflect the character of an establishment. XXL, as the name suggests, is designed to provide functional use of large meeting spaces and to accommodate for bigger meetings. Bearing the nature and splendor of wood in its elegant appearance, XXL is featured in 7 different size options -from 3.4 to 9 meters- to choose from.



XXL is easily distinguishable for its endurance as well as its connectivity solutions. True to today's needs, electrical and data connections are carried all the way up to the table top through the closed frame base. Outlets are secured and hidden by the lacquered, glass or eco-leather pads located in the center, accounting for an overall sharp and professional look.



DIMENSIONS (mm)

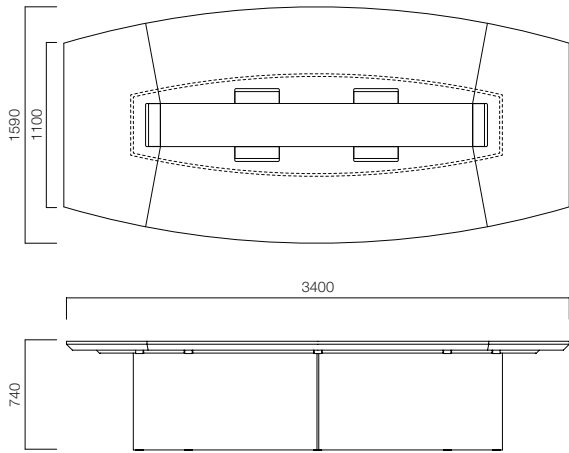

XXL L340
Ideal User Count for L340 Desk: 8p

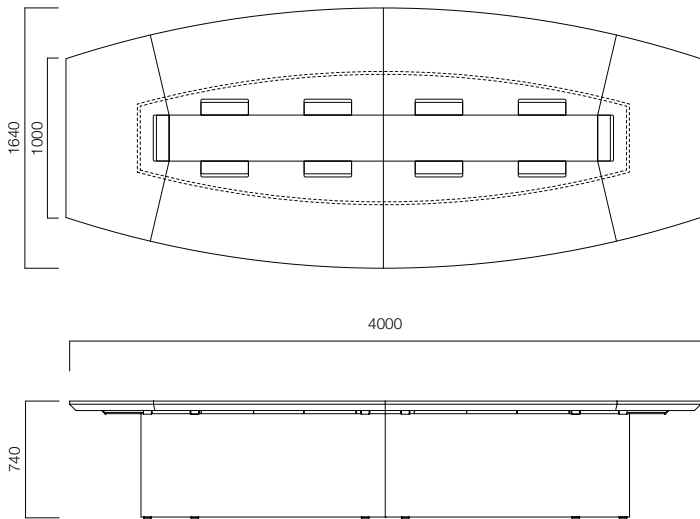

XXL L400
Ideal User Count for L400 Desk: 10p

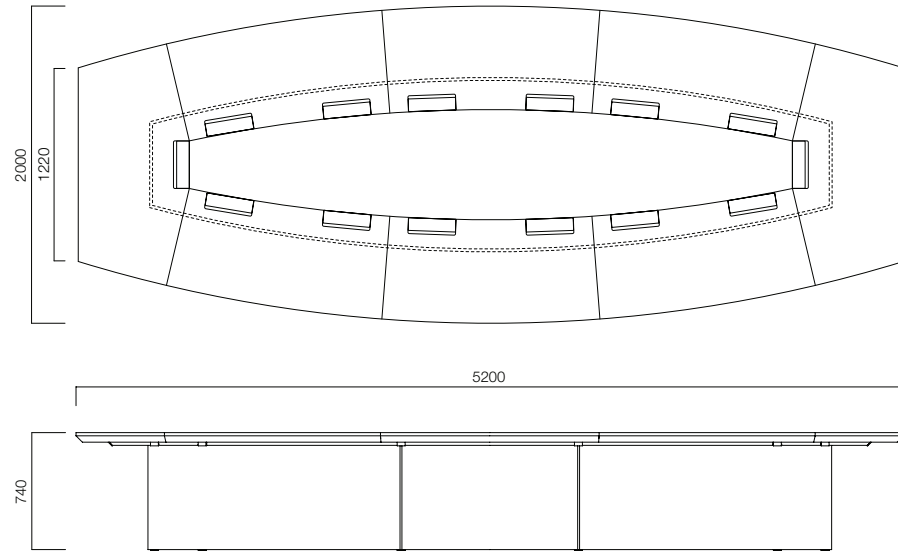

XXL L520
Ideal User Count for L520 Desk: 14p

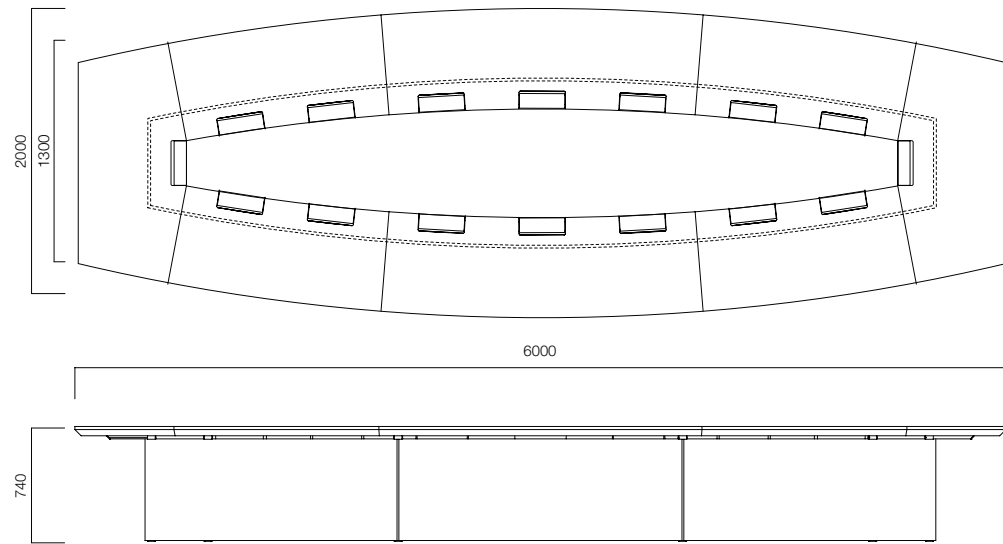

XXL L600
Ideal User Count for L600 Desk: 16p

DIMENSIONS (mm)

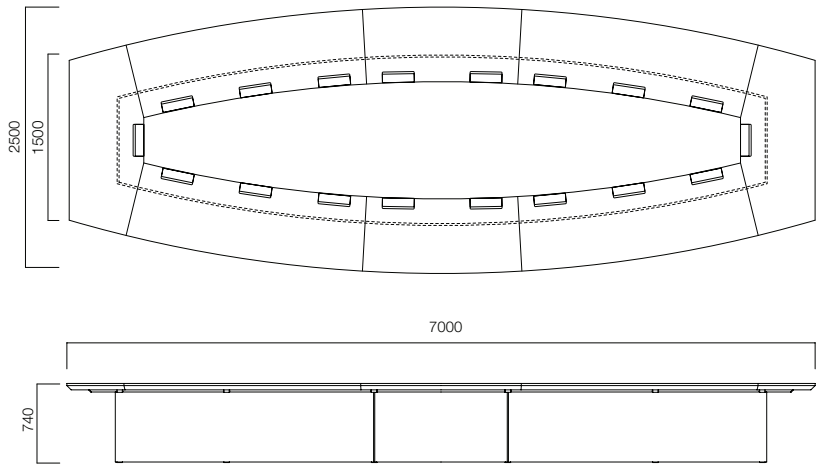

XXL L700
Ideal User Count for L700 Desk: 18p

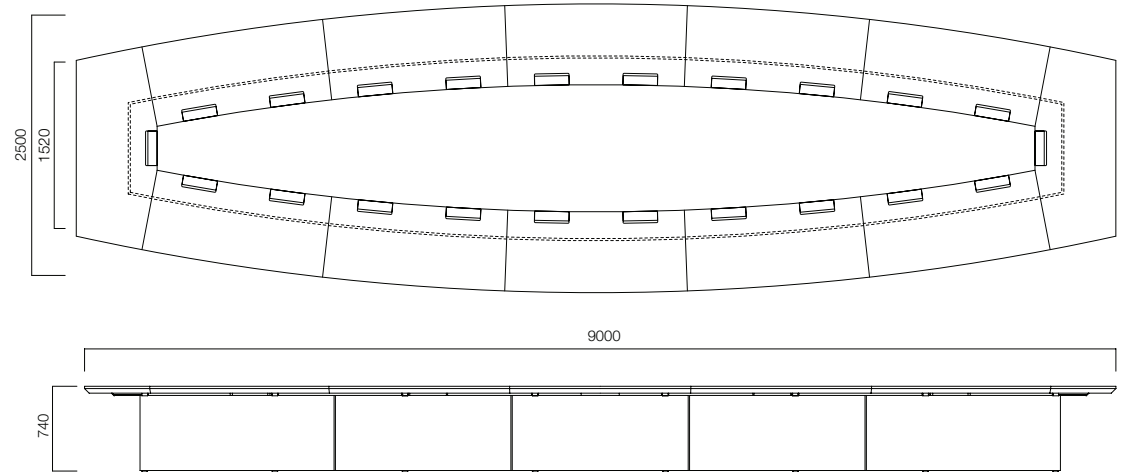

XXL L900
Ideal User Count for L900 Desk: 22p

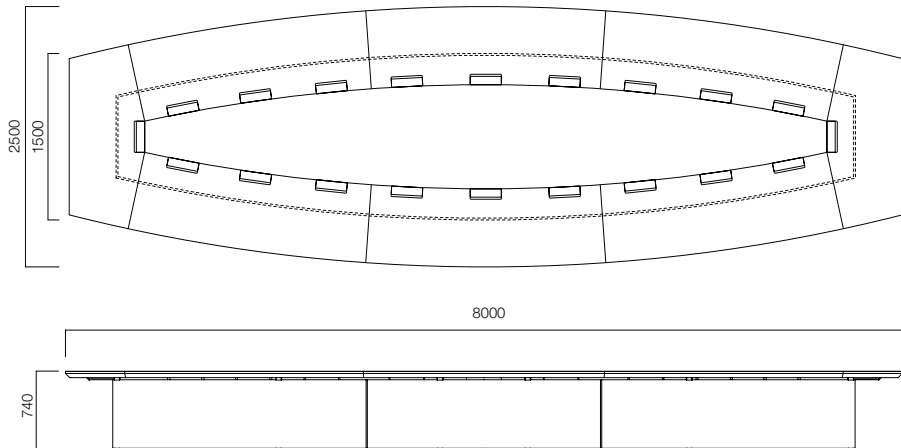

XXL L800
Ideal User Count for L800 Desk: 20p

nurus.com/xxl