

nurus

Connect Collection

Design by İnci Mutlu



Connection point for inspiration and change.

Connect adds rhythm and dynamism to interior design and usage areas with a unique design and circular form. Rich colour options and product family of Connect enables it to easily fit into areas of different interior designs and sizes, while adding a cosy atmosphere to waiting rooms and lounge areas.



Unusual circular form and unique design of Connect collection encourage socialization, creating lively and dynamic spaces. Rich colour options of Connect enables it to easily fit into characterization and interior design of usage area. Connect features a rich product family, including sofas, pouffes and coffee tables.

You can utilize Connect and Connect Jr. Sofas and pouffes together to create a variety of combinations and match your needs and architectural requirements of usage space. Connect sofas also offer a space to store your personal belongings, newspapers and magazines with movable coffee table choices. Connect is an ideal choice for various shared spaces including open offices, hotels, waiting rooms and lounge areas.



Connect Sofa + Pouffe



Connect Jr. Sofa + Jr. Pouffe

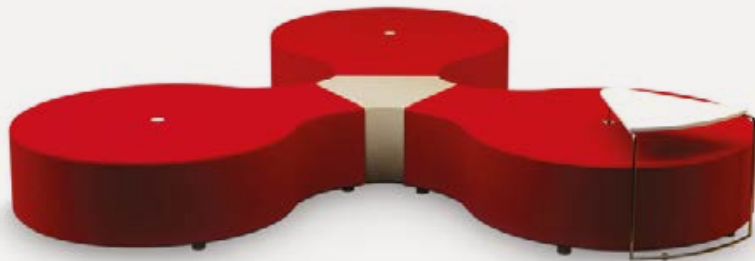

Connect Jr. Sofa + Triangle Pouffe



Connect Sofa



Connect Jr. Sofa



DIMENSIONS (mm)

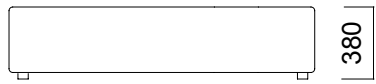
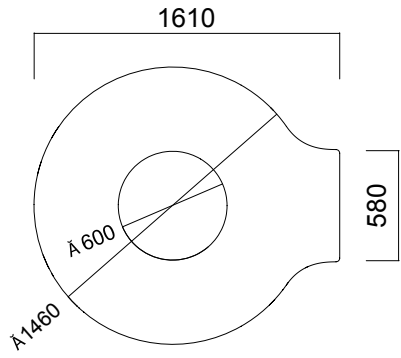

Connect Sofa

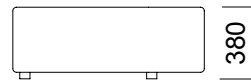
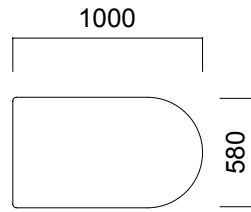

Connect Pouffe

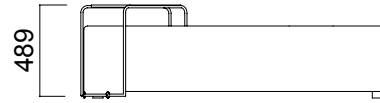
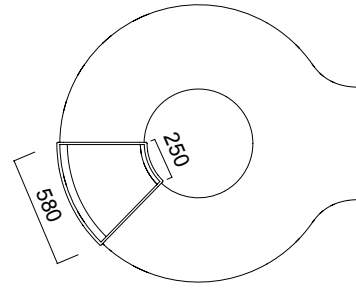

Connect Coffee Table

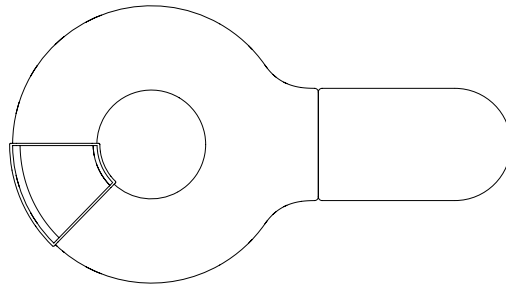
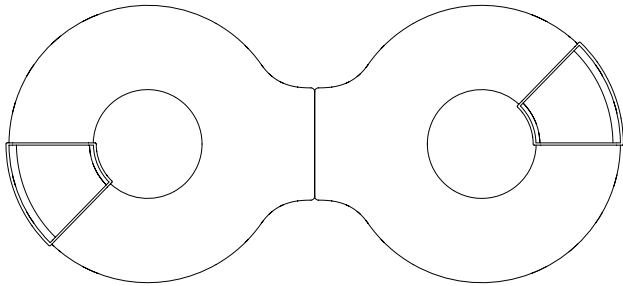

Connect Combinations

DIMENSIONS (mm)

Connect Jr. Sofa

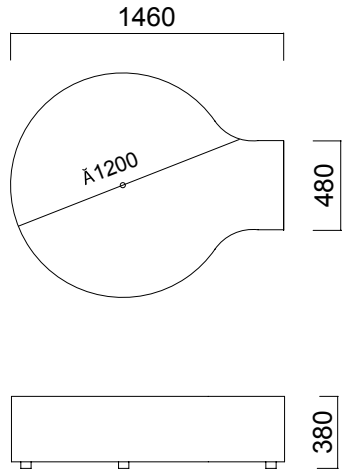

Connect Jr. Coffee Table

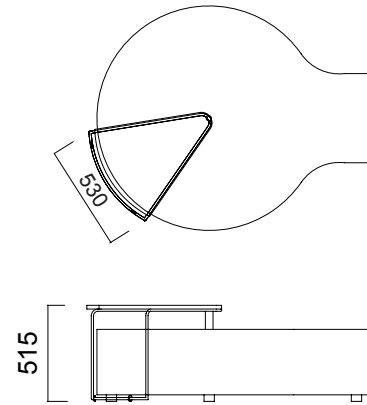

Connect Jr. Pouffe

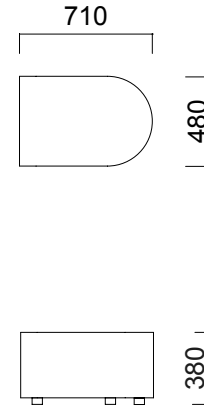

Connect Jr. Triangle Pouffe

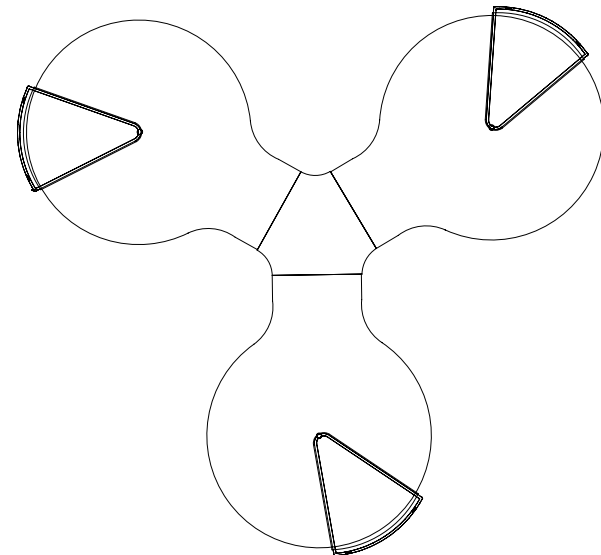
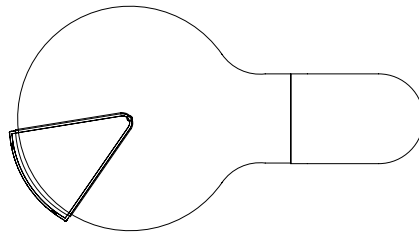
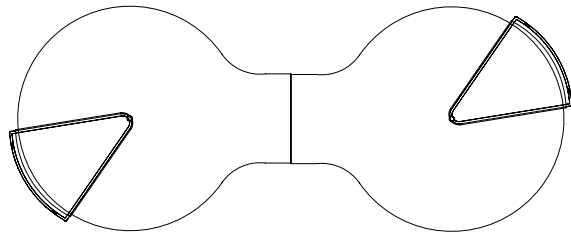
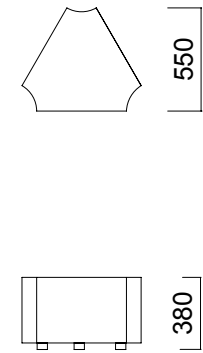

nurus.com/connect