

nurus

Stone Collection

Design by **Ece-Oğuz Yalim**



An assertive design inspired by nature.

Stone creates inspiring and eye-catching spaces with a statuesque look and a design to intensify the architectural texture. Facilitating space organization with a wide product family, Stone also provides solutions for work and education areas with technology support.



Stone strengthens desired effects in various spaces with its nature-inspired impressive design, angular form, and modular structure. Rich colour and fabric choices of Stone easily blends with usage space, its wide product family featuring sofas and pouffes enables assertive configurations in a series of areas from education and meeting halls to social spaces and homes.

Stone sofas were designed to adapt to ever-changing work culture, providing comfort and ergonomics. Stone helps users focus on the same direction with the optional table that can be mounted onto high backrest version; triangular pouffes meant for corners with optional coffee tables help create U form seating arrangements, while rectangle pouffes facilitate linear or L seating formations.

With the help of upholstered panels that can be mounted on sofas, this collection can help create private spaces with minimal environmental effects in social areas such as cafés and restaurants, open offices, waiting rooms and lounges, providing functional solutions for new generation education presentation, and meeting halls.

Stone square pouffes can be used individually or in groups of four to provide comfort in all living spaces, while triangular and rectangle 2 pouffes with **Nurus Links**[®] connection facilitate electronic device utilization with onboard USB ports.



High Backrest Sofa



Sofa & Pouffe Combination



Sofa



Sofa w/ Panel



Rectangle Pouffe



Square Pouffe



Triangle Pouffe



DIMENSIONS (mm)

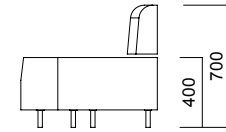
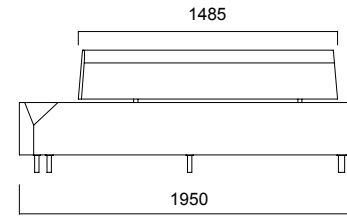
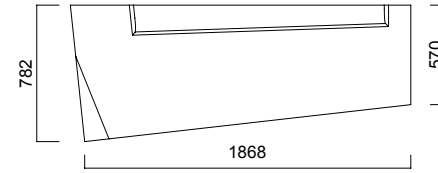

Sofa

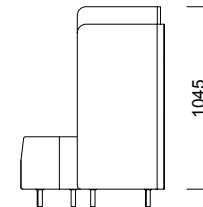
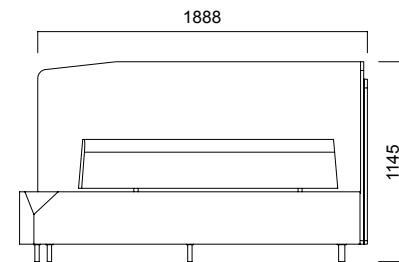
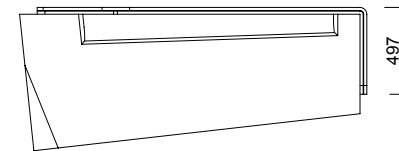

Sofa w/ Panel

DIMENSIONS (mm)

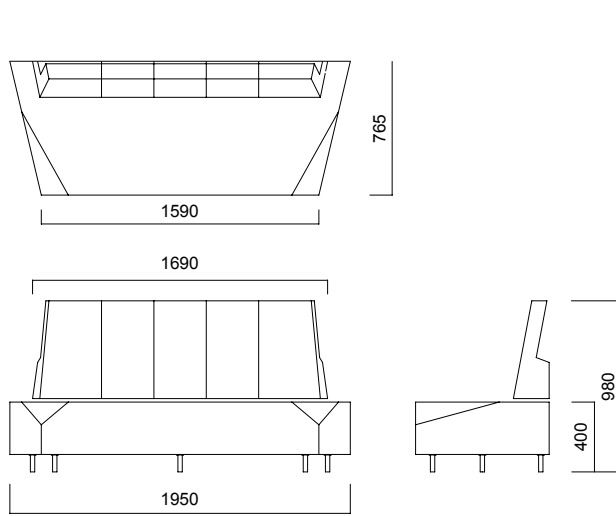

High Backrest Sofa

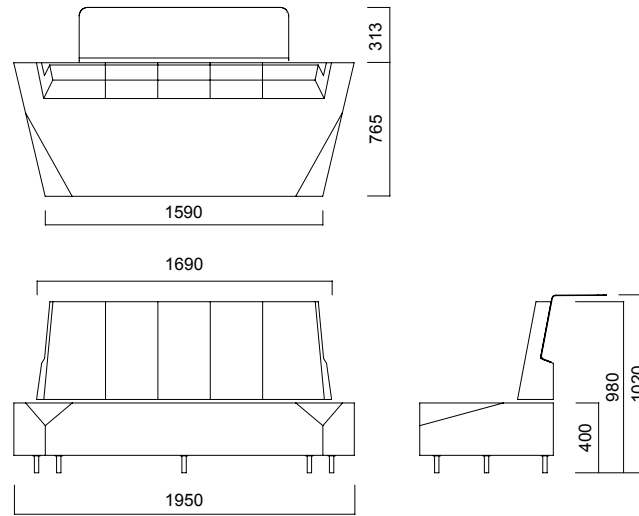

High Backrest Sofa w/ Table

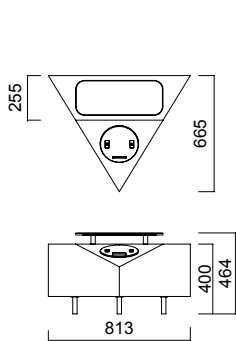

Triangle Pouffe

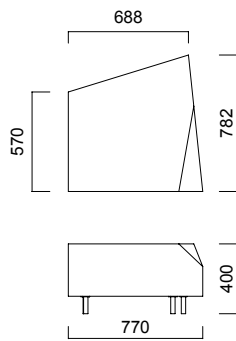

Rectangle Pouffe 1
Linear Order

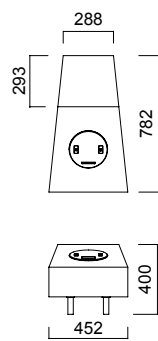

Rectangle Pouffe 2
Linear Order

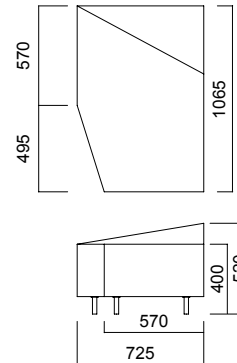

Rectangle Pouffe
L Order

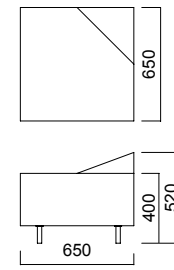

Square Pouffe

DIMENSIONS (mm)

Combinations

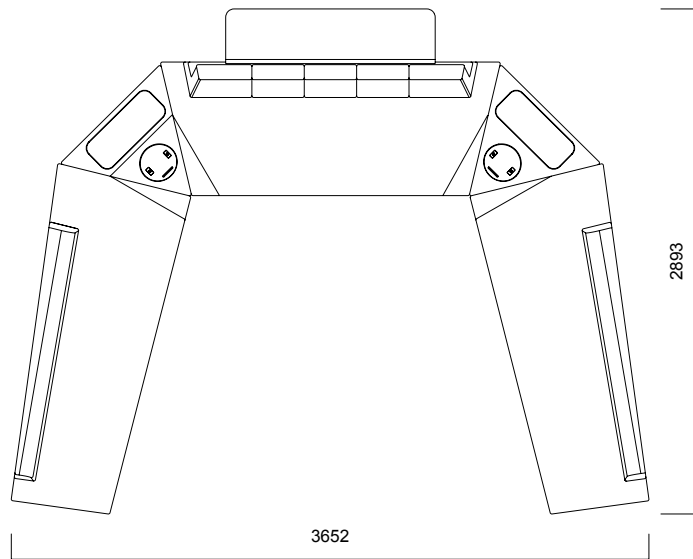

High Backrest Sofa w/ Table
Triangle Pouffe
Sofa Right Direction / Left Direction

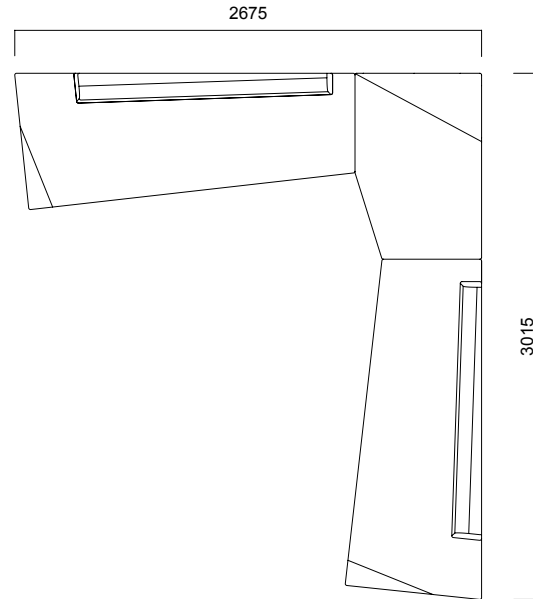

Sofa - Right Direction / Left Direction - Panel
Rectangle Pouffe L Order

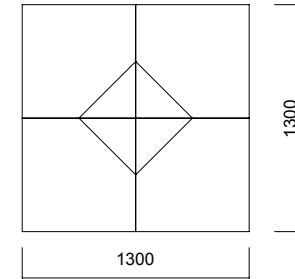

Square Pouffe

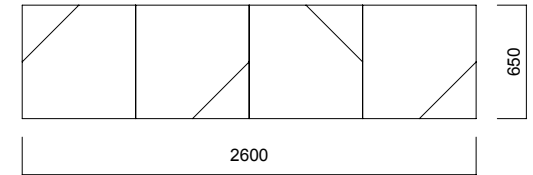

Square Pouffe

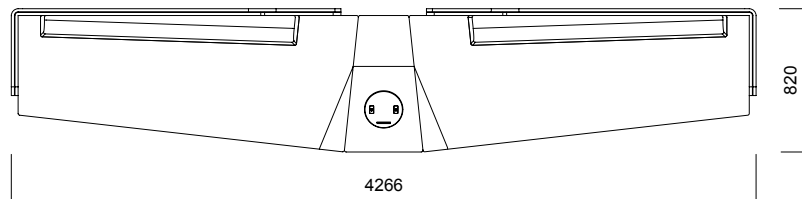

Sofa - Right Direction / Left Direction - Panel
Rectangle Pouffe 2 Liner Order

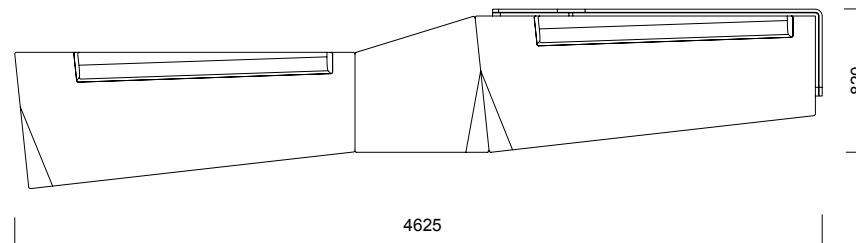

Sofa - Right Direction / Left Direction - Panel
Rectangle Pouffe 1 Liner Order

*Stone sofa and rectangle pouffe has different directions on L order.

**Stone High Backrest sofa with table only can used in combination. It can not be stand alone.

***Stone triangle pouffe has coffee table and electrification solution options.

****Stone rectangle 2 pouffe that forms liner order has electrification solution options.

nurus.com/stone