

nurus



U Too Single Desks

Design by **Aksu-Suardi**

U Too Single Desks

Simple and modern design of U Too single desks make them an excellent choice for home offices, as well as open offices and personal work spaces. Providing efficient use of workspace with the help of storage units, single desks also create functional and stylish workspaces with elegant legs and blunt desk corners.

Design by Aksu-Suardi

Following his works in Stuttgart, Paris ve Milano, Sezgin Aksu started working in collaboration with Michele De Lucchi in his Milano based studio in 1996. Silvia Suardi started her career in Michele De Lucchi Studio, and worked there for 10 years. In 2001, her and Sezgin Aksu together established AKSU/SUARDI Studio, where they provided industrial, furniture, and graphic design in a wide range from public spaces to home decoration. Certain brands they have provided consultancy services to include Antonangeli, Caimi Brevetti, Credit Agricole Asset Management (CAAM), Eurizon Capital Sgr Spa, eDePadova, Gebrüder Thonet Vienna, Nemo-Cassina, Poltrona Frau, Olivetti, Rubinetteria Teorema, Slide and Serafino Zani.



reddot design award
winner 2007

DIMENSIONS (mm)

Glass Tables

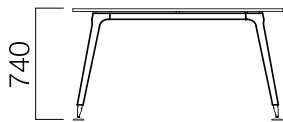
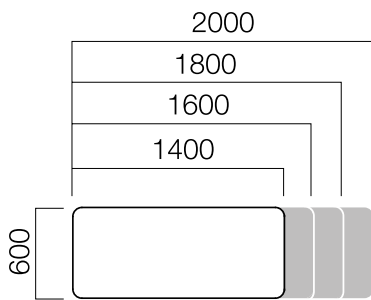

W:60 cm Glass Side Table

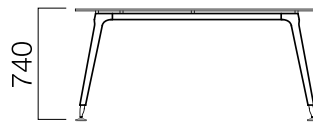
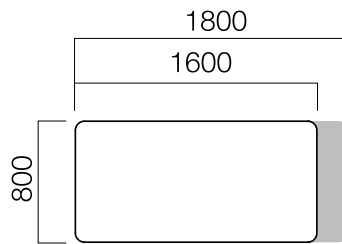

W:80 cm Glass Table

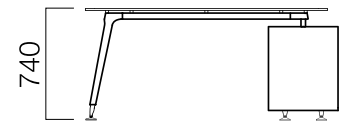
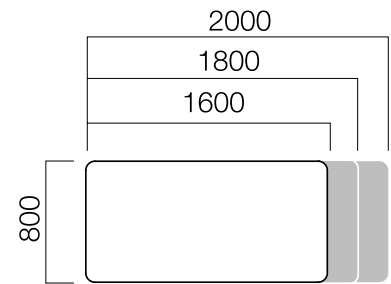

W: 80 cm Two-Leg Glass Table

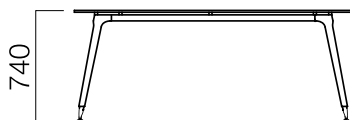
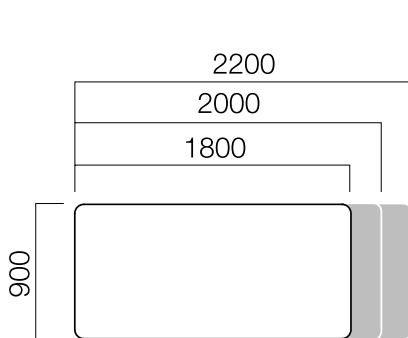

W:90 cm Glass Table

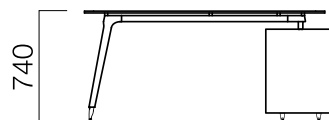
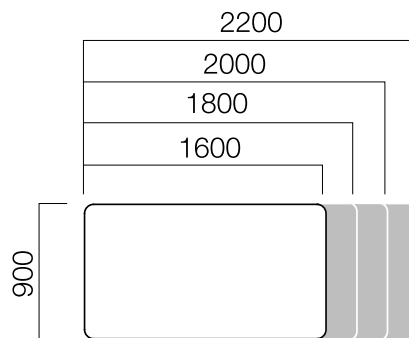

W:90 cm Two-Leg Glass Table

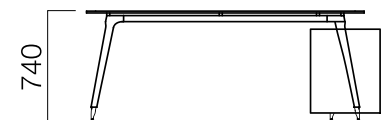
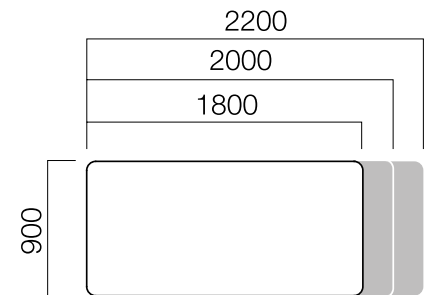

W:90 cm Three-Leg Glass Table

DIMENSIONS (mm)

Glass Tables

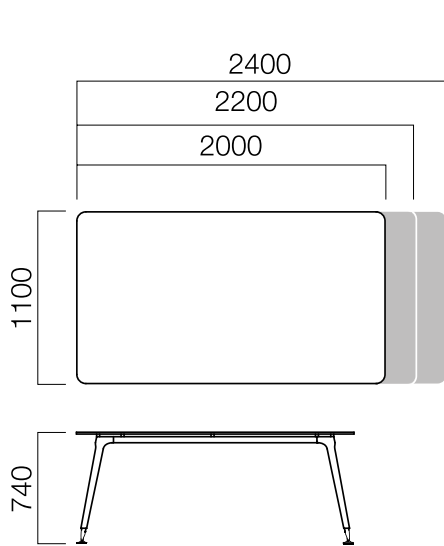

W:110 cm Glass Table

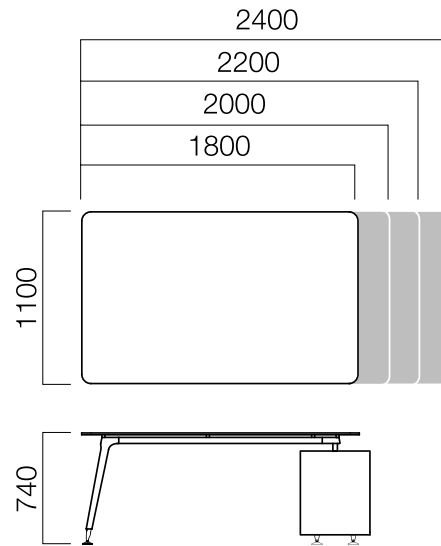

W:110 cm Two-Leg Glass Table

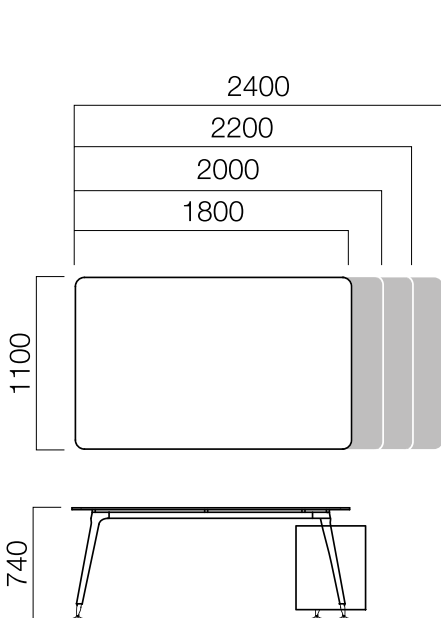

W:110 cm Three-Leg Glass Table

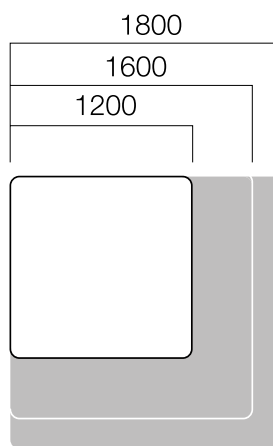

Square Glass Table

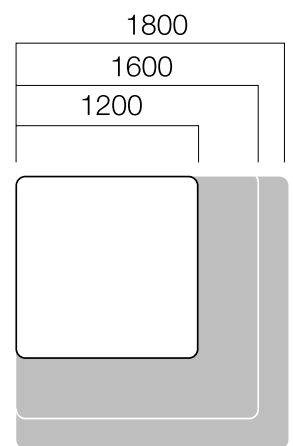

3-Leg Square Glass Table

DIMENSIONS (mm)

Single Desks

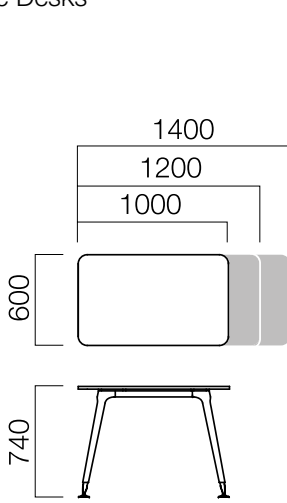

W:60 cm Desk

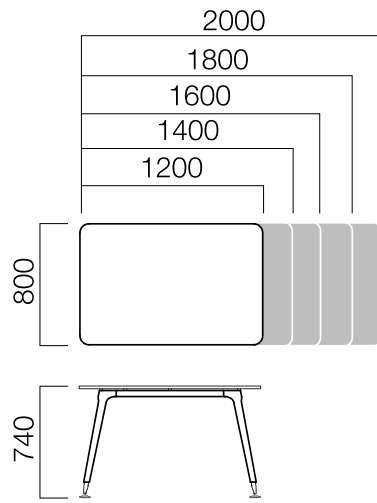

W:80 cm Desk

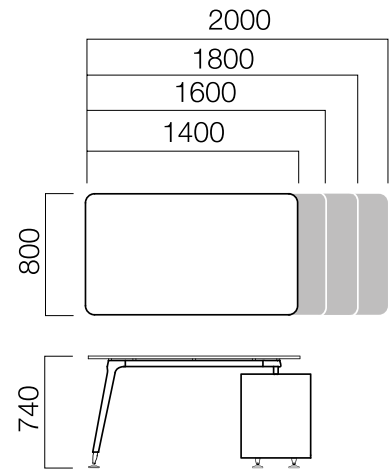

W:80 cm 2 Leg Desk

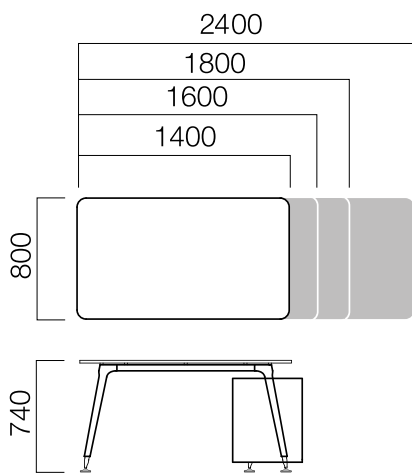

W:80 cm 3 Leg Desk

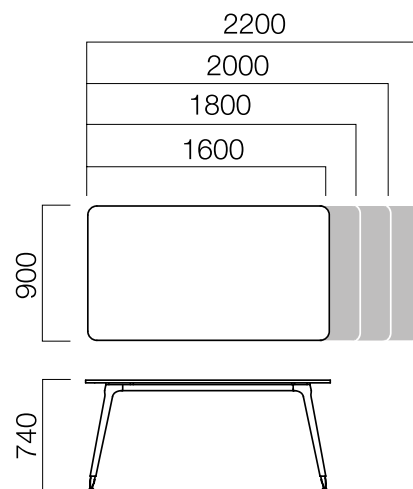

W:90 cm Desk

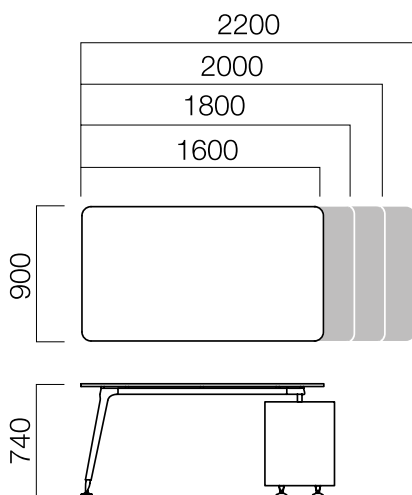

W:90 cm 2 Leg Desk

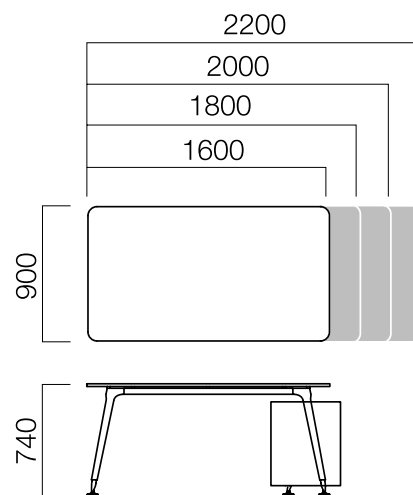

W:90 cm 3 Leg Desk

DIMENSIONS (mm)

Single Desks

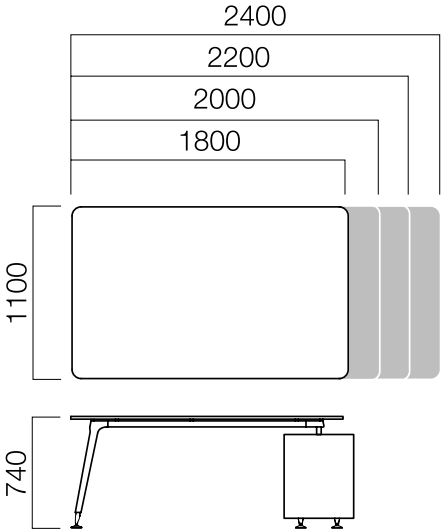

W:110 cm Desk

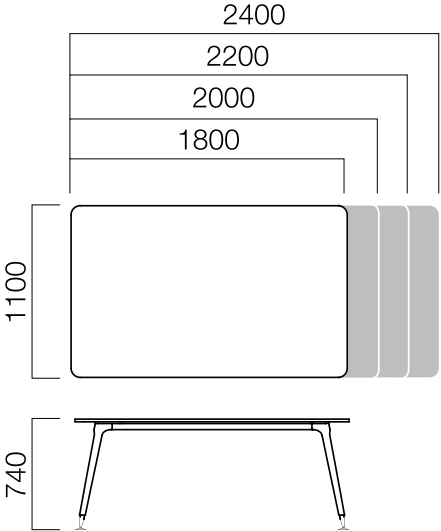

W:110 cm 2 Leg Desk

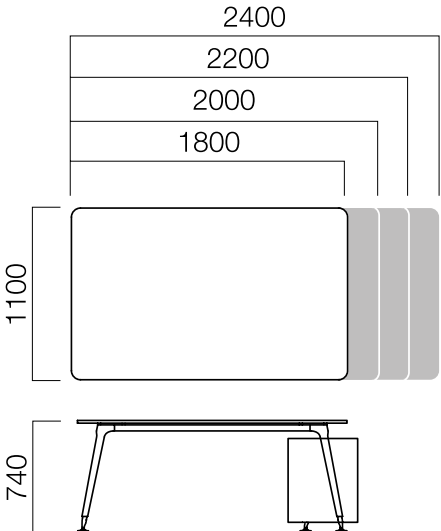

W:110 cm 3 Leg Desk

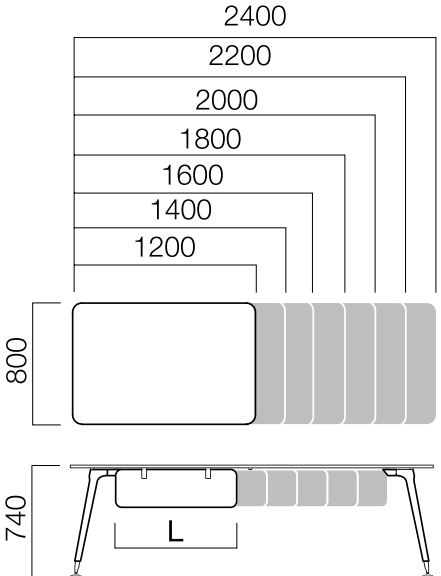

Front Panel

*L: -60 cm from table length.

DIMENSIONS (mm)

Commodes

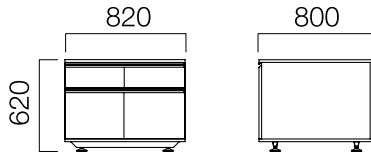

CPU Commode

*Features 1-drawer, 1 File Drawer and 3-drawer versions.

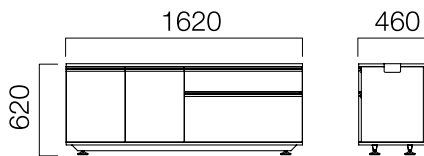

One Sided Commode
2 Drawers 2 Lids

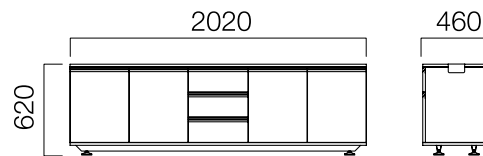

One Sided Commode
3 Drawers 4 Lids

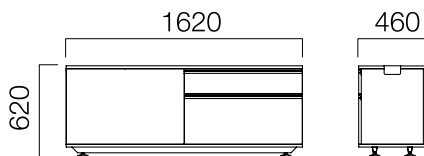

Double Sided Commode
4 Drawers

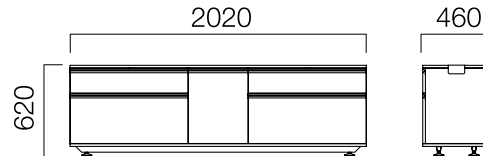

One Sided Commode
4 Drawers 1 Lids

Dimensions defined in millimetres.

Materials

Desk slab choices include painted glass (at certain sizes), melamine, natural veneer, vintorio veneer, recomposed veneer, compact recomposed veneer, or compact laminated. Desk legs are made of powder painted aluminium profile. Touches the ground via footing made of chrome plated aluminium and metal.

Front panel features melamine, lacquered, acrylic, natural veneer, vintorio veneer, and recomposed veneer options.*

* Please refer to technical document for more information.