

nurus

Fe2 Collection

Design by **Nurus D Lab**



Orderly and functional living spaces with Fe2.

Fe2 was designed with the awareness that each field has different storage needs. Featuring different material choices, Fe2 provides flexible and functioning storage solutions for all living spaces including homes, executive offices, and open offices.



Fe2 was designed in consideration of different storage needs in all living spaces, from homes to executive offices and open offices. Rich product family of Fe2 features open-shelf cabinets, door cabinets, and cloak cabinets, providing flexible and functioning solutions for all storage requirements.

Fe2 can also be utilized to separate working space into several sections, facilitating efficient use of space.

Melamine and veneer choices featured in cabinet doors and rear panels of Fe2 collection seamlessly blends into usage space.



Fe2 Cabinets with Aluminium Frame Acrylic and Glass Doors



Fe2 Open-Shelf Cabinets with Aluminium Frame Acrylic and Glass Doors



Fe2 Cloak Cabinets with Glass Doors



Fe2 Open-Shelf Cabinets



Fe2 Open Cabinets



Fe2 Open-Shelf Door Cabinets



Fe2 Cabinets with Doors



FE2 Cloak Cabinets with Doors

DIMENSIONS (mm)

Cabinets

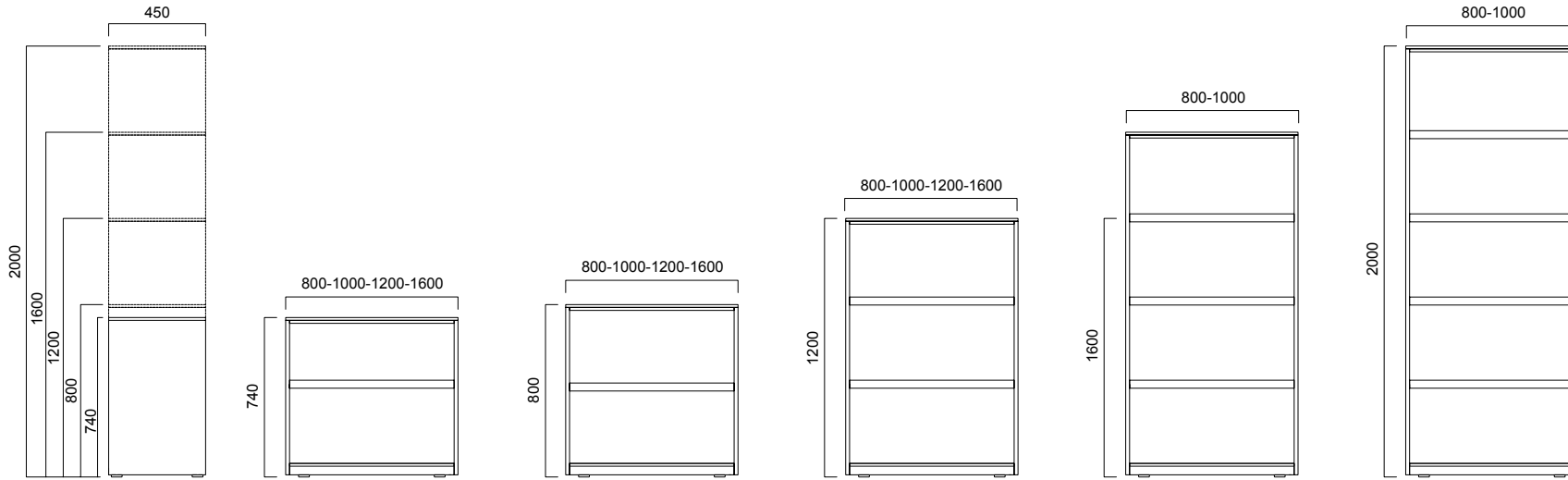

Fe2 Open-Shelf Cabinet

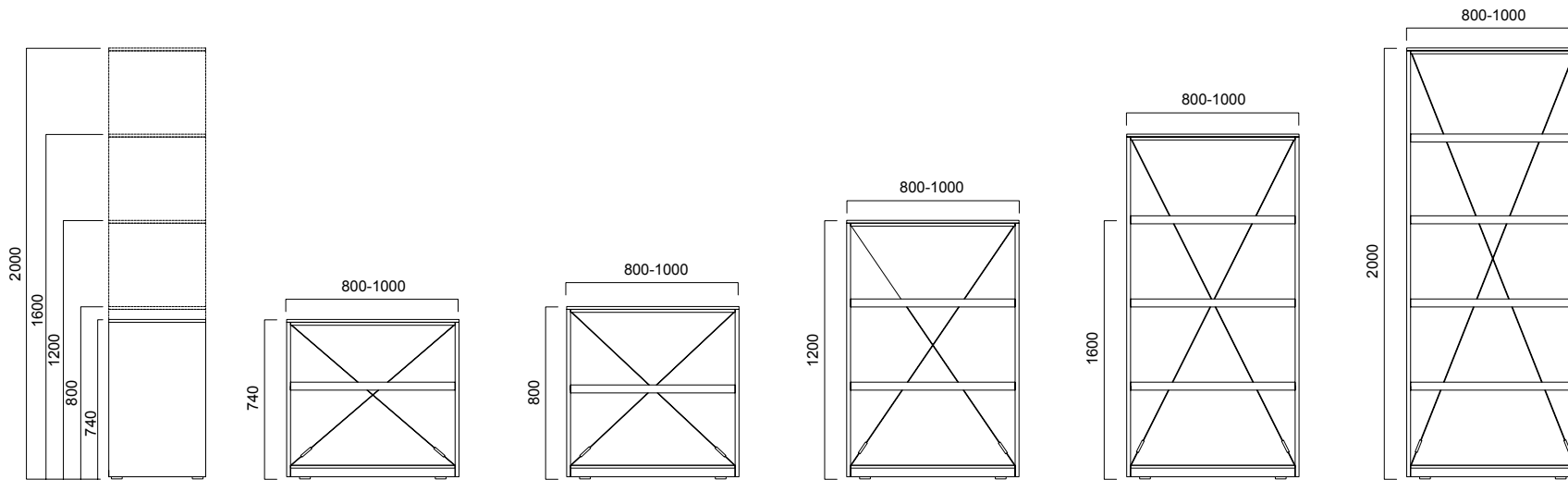

Fe2 Open Cabinets

DIMENSIONS (mm)

Cabinets

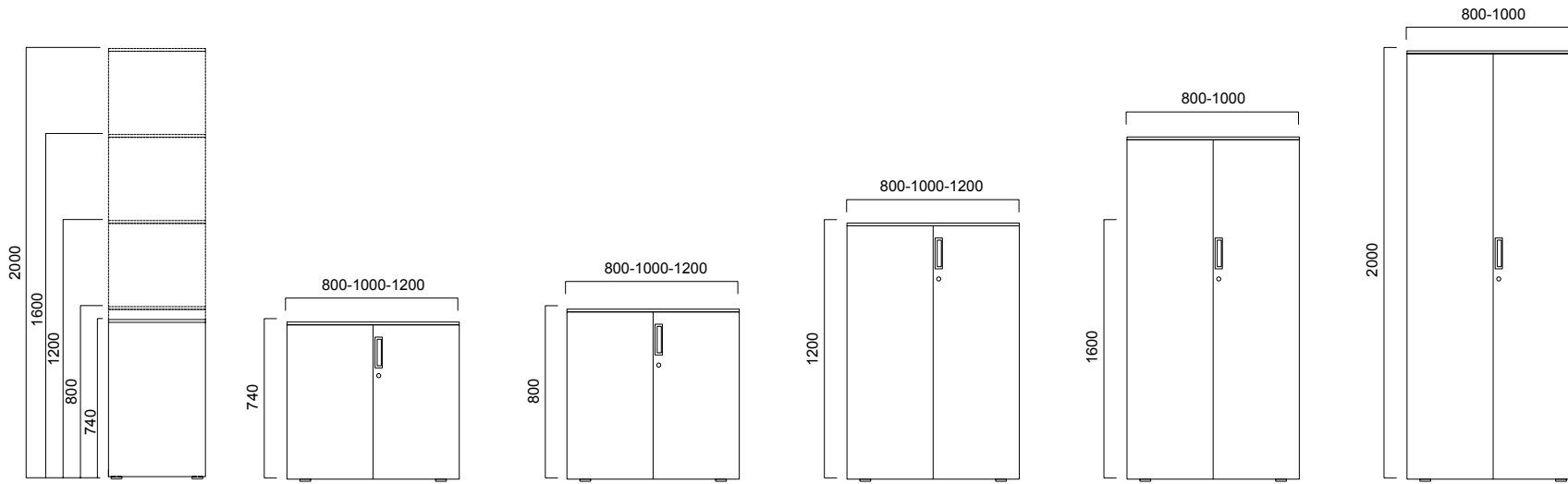

Fe2 Cabinets with Doors

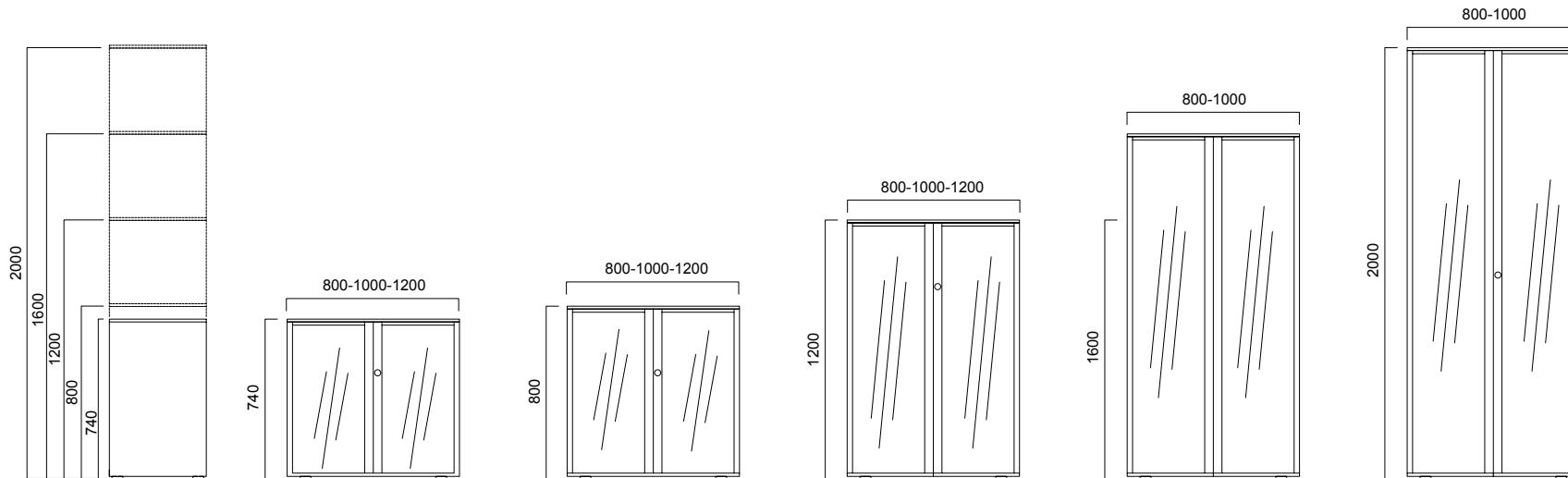

Fe2 Cabinets with Acrylic and Glass Doors

DIMENSIONS (mm)

Cabinets

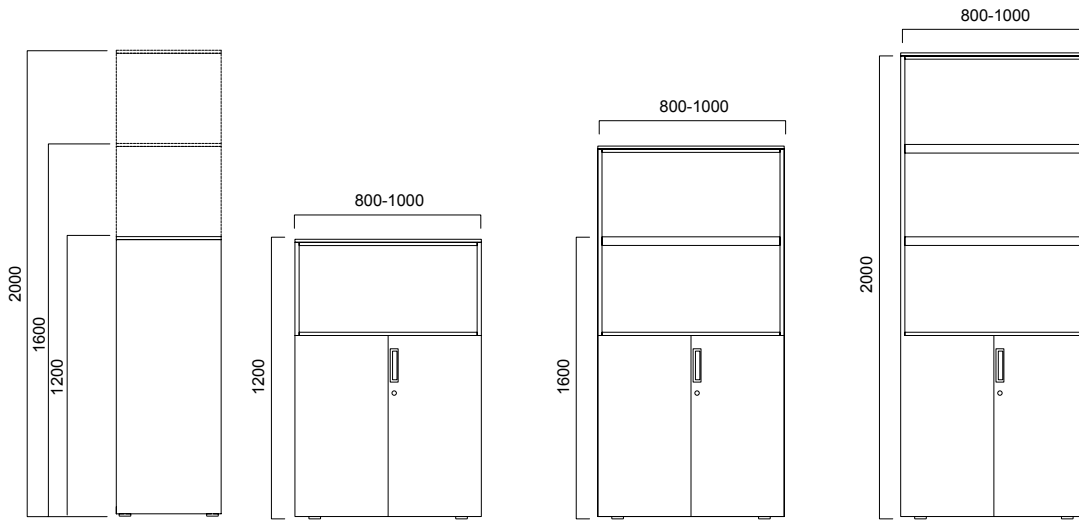

Fe2 Open-Shelf Door Cabinets

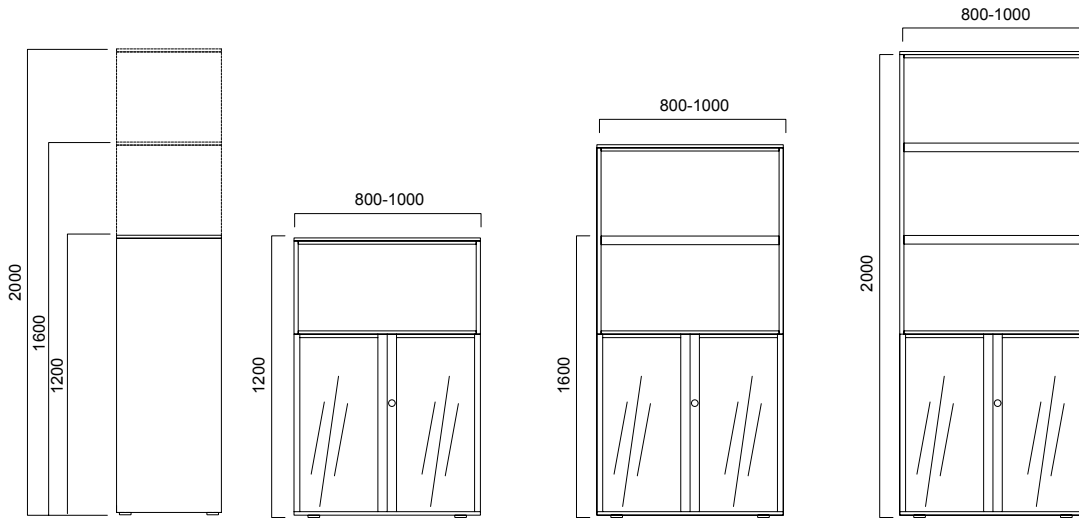

Fe2 Open-Shelf Cabinets with Acrylic & Glass Doors

DIMENSIONS (mm)

Cabinets

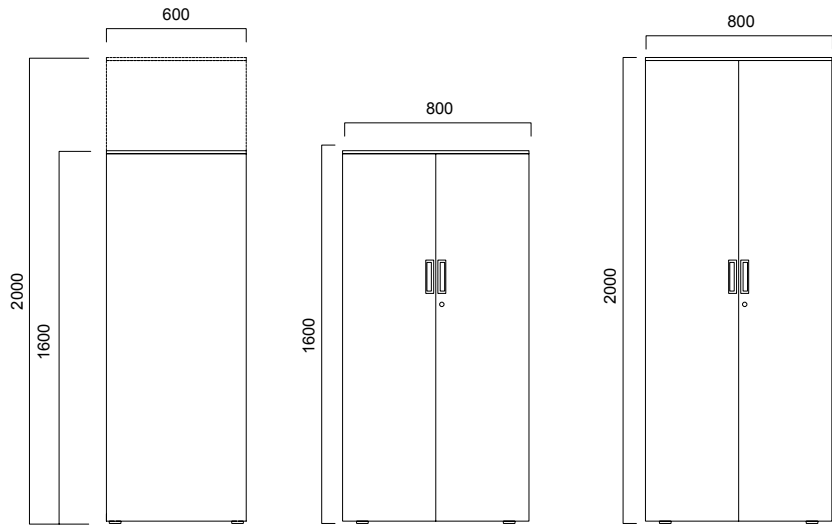

Fe2 Cloak Cabinets with Doors

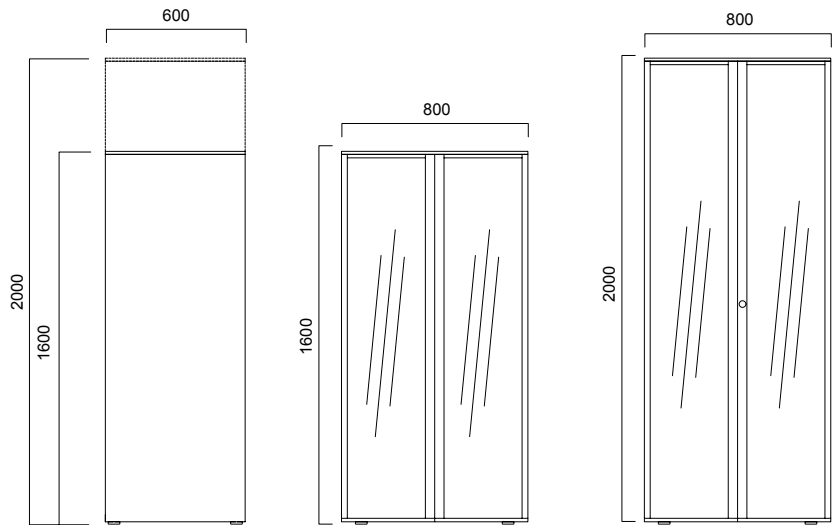

Fe2 Cloak Cabinets with Acrylic & Glass Doors

nurus.com/fe2